





2/2-way Solenoid Valve with servo-piston for higher pressures

- Solenoid valve with servo-piston
- Pressure range up to 725 PSI
- Push-over solenoid system
- Adjustable switching times for DN 20 to 25
- Approvals:     

Type 5404 can be combined with...

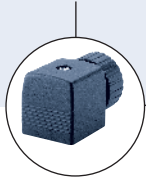

Type 2508
Cable plug



Type 1078
Timer unit

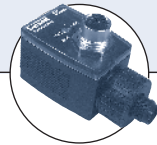

Type 2511
ASI cable plug



Type 8600
Dosing control

This pilot-controlled solenoid valve with servo-piston is closed without power and is suitable for the control of liquid and gaseous media at high pressures. A minimum differential pressure of 14.5 PSI (1 bar) is required to fully open the valve. The closing time for DN 20 and 25 can be continuously adjusted.

Circuit function A

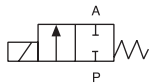

2/2-way valve, normally closed by spring force

Circuit function B

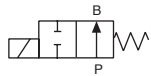

2/2-way valve, direct-acting, normally open (on request)

Technical data

Orifice	7/16" – 1" (DN 12 – 25 mm)
Body material	Brass
Valve internals	Stainless steel, brass
Seal material	NBR, PTFE seat seal
Media	Neutral media, compressed air, water, hydraulic oil
Media temperature	14°F to 194°F (-10°C to +90°C)
Ambient temperature	Max. 131°F (+55°C)
Voltage tolerance	±10%
Duty cycle	100% continuous rating
Electrical connection	Tag connector according to DIN EN 175301-803 (previously DIN 43650) Form A (see Ordering chart for accessory on page 4)
Protection class	IP 65 with cable plug
Installation	As required, preferably with actuator upright
Response times	
Opening [ms]	20-400
Closing [ms]	100-1500 (depending on orifice and differential pressure)

Power consumption

Inrush AC [VA]	Hold (hot coil)	
	AC [VA/W]	DC [W]
24	14/8	8

Materials

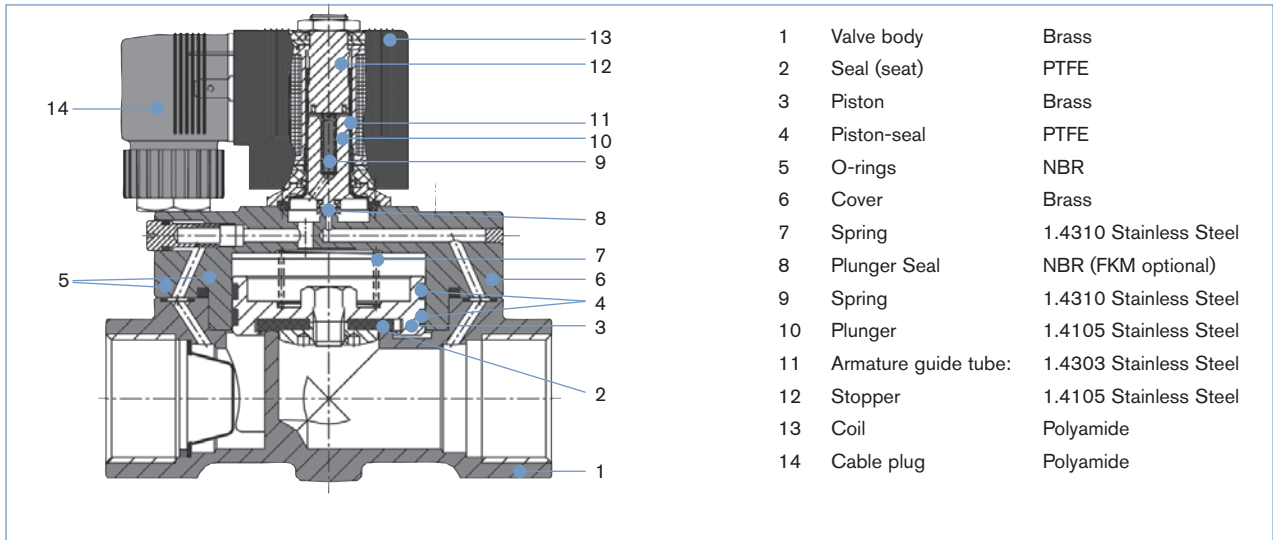

Ordering chart for valves (other versions on request)

Brass body, with cable plug (please see footnote and/or Accessories)

Circuit function	Orifice [mm]	Port connection NPT	C _v value water [GPM]	Pressure range for approved valves [PSI]	Voltage/frequency [V/Hz]	Item no. UL listed/CSA/FM/CE	Item no. UL recognized/CSA/CE	Item no. Non-approved versions 14.5 - 725 PSI
A 2/2-way valve NC 	12	NPT 1/2	2.3	14.5 - 362	024/DC	457 858	456 938	US06505
					024/60	457 859	456 939	US09326
					120/60	457 860	456 940	US05795
					240/60	457 861	456 941	US09327
	20	NPT 3/4	5.8	14.5 - 362	024/DC	457 862	456 942	-
					024/60	457 863	456 943	-
					120/60	457 864	456 944	-
					240/60	457 865	456 945	-
	25	NPT 1	11.7	14.5 - 362	024/DC	457 866	456 946	-
					024/60	457 867	456 947	-
					120/60	457 868	456 948	-
					240/60	457 869	456 949	-

Note: the pressure values for liquid media are shown on the rating plate! Circuit function NO (B) on request.

Note: UL listed valves include Type 2509 1/2" conduit plug. All other valves include Type 2508 series standard cable plug.

Dimensions [mm]

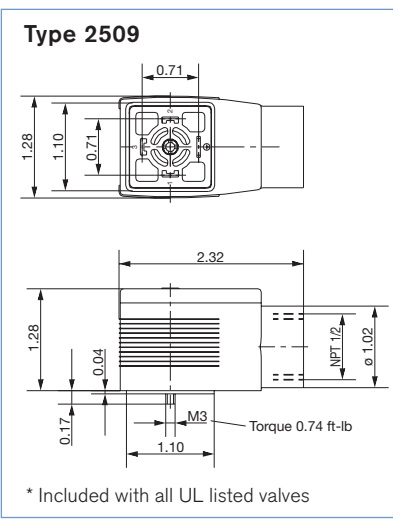
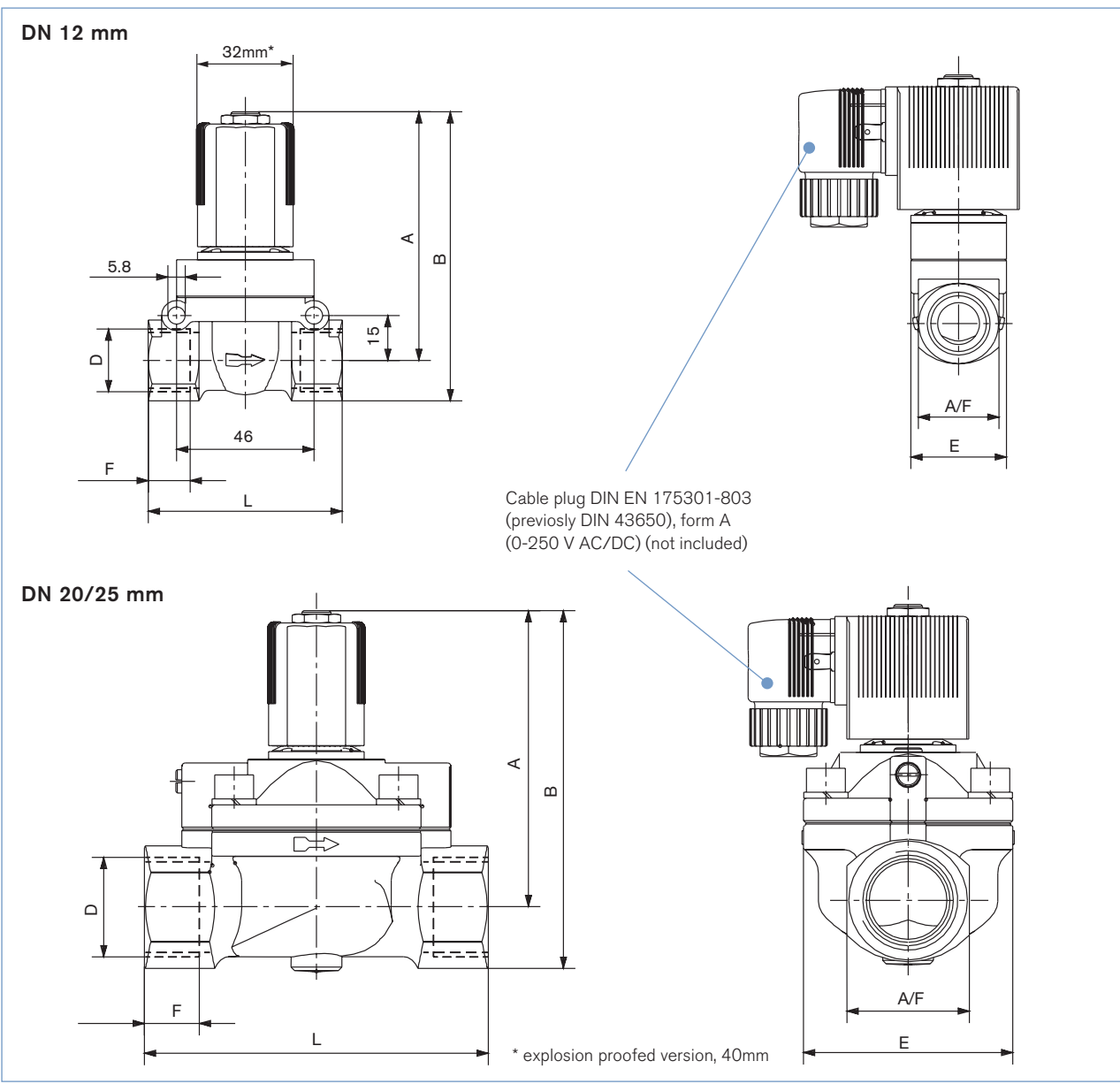

Variable dimensions [mm]

Port connection D	Orifice [mm]	A	B	F	E	L	A/F
NPT 1/2	12.0	83.00	96.5	14.0	32	65	27
NPT 3/4	20.0	93.0	109.0	16.0	60	100	32
NPT 1	25.0	99.5	119.0	18.0	70	115	41

DTS 1000082562 EN Version: A Status: RL (released | freigegeben | valide) printed: 09.05.2016

i Further versions on request



Circuit function
Circuit function NO (B)



Material
Seal: FKM



Approvals
UL, UR, CSA, Hazardous Locations Expl. proof, EEx m/ed

Ordering chart for accessories

Cable plug Type 2508 according to DIN EN 175301-803 Form A

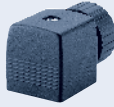
	Circuitry	Voltage / frequency	Item no.
	None (standard)	0 - 250 V AC/DC	008 376
	with LED	12 - 24 V AC/DC	008 360
	with LED and varistor	12 - 24 V AC/DC	008 367
	with rectifier, LED and varistor	12 - 24 V AC/DC	008 363
	with LED	200 - 240 V	008 362
	with LED and varistor	200 - 240 V	008 369
	further versions see datasheet Type 2508		

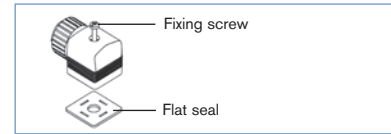

The delivery of a cable plug includes the flat seal and the fixing screw. For other cable plug versions acc. to DIN EN 175301-803 Form A (previously DIN 43650), see separate datasheet Type 2508.