

Demand-controlled ventilation in vehicle parks

H. Martin, SenseAir AB

The aim of this document:

To provide a basis for discussion in purchasing and demand specification of cost-effective solutions for energy-efficient ventilation control and reliable gas detection in garages.

CONNECTING SENSEAIR DOCUMENT:

iMSENSEII	<i>M-SENSE II multi sensor (users´ manual)</i>
TN-012	<i>About CO gas sensors...</i>
TN-020	<i>Measuring method for emissions in road tunnel systems</i>

Introduction

Social developments today are moving towards an increasing awareness of the questions of environment and health. In the construction and property management sectors, public safety and health form the basis of the various official requirements and norms which must be met in different contexts.

Together with a general awareness of global environmental problems, it is becoming increasingly clear that revolutionary changes must occur in our daily lives if we are to create an ecologically sustainable society. By signing the Kyoto agreement of 1997, we have, for example, committed ourselves as a nation to limiting carbon dioxide emissions in an attempt to meet the threat of the global greenhouse effect. Commitments such as these give rise in their turn to new official demands in the construction and planning industries, where standards and international conventions are now being reformulated to include e.g. lifestyle analysis, circulation awareness and energy efficiency.

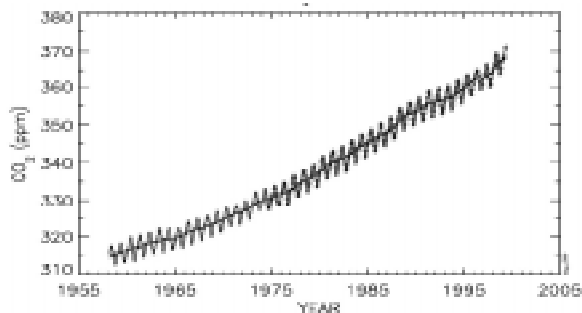

Figure 1: Increase of carbon dioxide in the earth's atmosphere registered at a high-altitude observation site in the Pacific Ocean.[1].

Rules System

As far as improved energy efficiency and requirements for reduced energy-use are concerned, the present Swedish building standards have been formulated to enable demand-control and energy-recycling of heat, cooling and ventilation. In the rules systems of the future [2] these energy conservation measures will be legal requirements. Concern for the individual's right to a good public environment and a healthy indoor climate is combined with the international demand for concern for our planet.

Today's Swedish regulation BBR 94 (BFS 1998:38, chapter 6:232) reads as follows regarding air exchange:

"Rooms shall have continuous air exchange during use. Fresh air flow shall be at least 0,35 l/s per m² of floor area. When the room is not in use, the airflow may be reduced, but not to such an extent that risks to health arise, or in such a way as to risk damage to the building or its installations. The reduction may occur continuously or by intermittent stages..."

This is followed by specific advice on dimensions of air intakes for various types of locale. This advice is based on collective experience and is intended to guide construction work so that building norms are fulfilled and sufficient ventilation guaranteed. In the case of garages for more than one vehicle, the advice is *"1,8 l/s per m² of floor area"*.

However, the consequence of the new demands for efficient energy use is that one should no longer ventilate to excess. With the help of heat recycling, where this is possible, a lot of energy can of course be saved. But even efficient heat-exchangers are not

SUBSTANCE	TWA (8 tim)	STEL (15 min)
Carbon monoxide (CO)	20 ppm	100 ppm
Nitrogen dioxide (NO ₂)	1 ppm	5 ppm
Carbon dioxide(CO ₂)	5000 ppm	10 000 ppm

Table 1: Hygienic Limit Values acc.to. AFS 1993:9 when the source is exhausts.

100% efficient. Their motors, in conjunction with the rest of the fan-system and the above-mentioned energy-loss, use energy unnecessarily, unless the airflow is reduced when the demand drops. In other words, a constant balance must be maintained, even under variable load, between sufficient and necessary air-exchange. The only reasonable way to achieve this is to control ventilation by demand with the help of a continuous gathering of information from climate sensors.

Limit Exposures

It is clear that in order to control ventilation by demand the minimum requirements for air-quality must be met. In physiological terms, the minimum requirement is always to be seen in relation to the intended use of the locale, including the time of use per visitor that the locale is intended for. In this case the regulations rely on the Swedish employee protection agency's declaration from 1993, where among other things *Hygienic limit exposures* (see Table 1) are specified, i.e. perfectly acceptable average values (Time Weighted Average Exposure - TWA) for contaminants in inhaled air. Depending on expected exposure time (time of visit) for a particular substance a distinction is drawn between TWA – usually calculated over a normal 8-hour work day, for five-day working week – and the Short-Term Exposure Limit (STEL), a 15-minute time weighted average exposure which should not be exceeded at any time during a working day.

It is generally held that in garages vehicles provide the primary source of contamination, and that ventilation systems should therefore be specified and run on the basis of vehicles' gas emissions. In most cases carbon monoxide (CO) is thought to present the greatest danger. But in locales with heavy loads of diesel vehicles, e.g. bus garages or transport terminals, nitrogen oxides present a more serious threat; especially if the locale is a place of work where an employee may be expected to spend the whole working day. In that case the stricter requirement not to exceed the threshold limit exposure applies. Most Swedish garages however are used only as parking spaces. The short-time limit exposure then applies, since nobody is expected to spend more than 15 minutes per visit.

Which gases are relevant to measurement?

In the case of contamination from vehicles, the traditional view has been that CO and NO_x have presented the greatest risk. AFS1993:9 states that if vehicle exhausts are the source then the Threshold limit value is 1 ppm (part per million) for nitrogen dioxide (NO₂) and 20 ppm for carbon monoxide. When exhaust emissions are not the source, then values twice as high are permitted for these substances. The purpose of these stricter requirements for garages is to include the effects of other dangerous substances which also occur in exhaust fumes. In this way CO and NO₂ (usually one of them, depending on the type of garage) are used as indicators for dangerous substances.

In many exhaust-measurement contexts it can, however, be better to measure CO₂ (carbon dioxide), instead of measuring every toxic component which might occasionally occur [3]. In open spaces, when the oxygen in the air cannot be depleted, CO₂ is always the dominating product of combustion. (Figure 2). It therefore provides a good measure of the total amount of accumulated exhaust, and, consequently, of the ventilation requirements. By controlling ventilation in accordance with CO₂-levels one is certain that all other contaminants which are present in exhausts disappear with the carbon dioxide. 1330 ppm CO₂ is an 8-hour limit value (indicator substance) that has been suggested after a study of diesel exhaust [3]. Carbon dioxide can be measured more precisely and reliably than the detectors for toxic substances which might otherwise be considered. In addition, SenseAir's sensors are maintenance-free, which minimises running-costs.

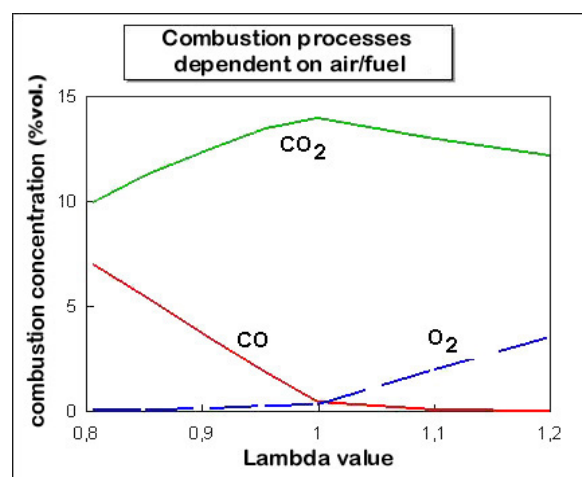

Figure 2: A typical hydrocarbon combustion illustrated with its air/fuel ratio and the resulting exhaust mixture. Oxygen deficiency, i.e. $\Lambda < 1$, results in increased CO-generation. In car engines. $\Lambda = 1$ is adjusted ± 0.01 , which gives optimal combustion = maximal CO₂ - level. $\Lambda > 1$ gives undesirable quantities of nitrogen oxides in the exhaust.

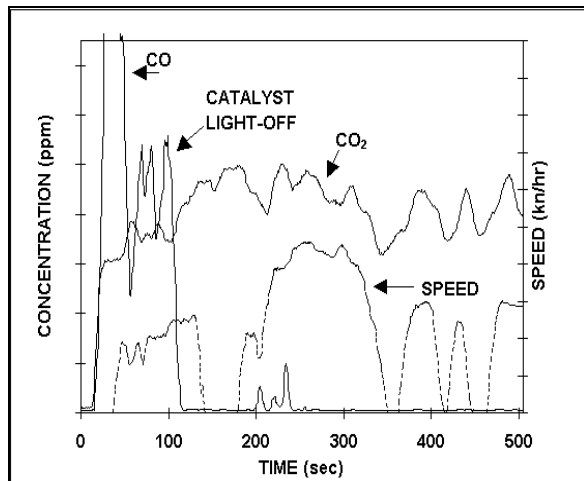

Figure 3: Emissions registered from a car with catalytic converter after cold start with subsequent typical driving scenario.

Carbon Dioxide – an overlooked threat!

The rapid development of environmentally friendly cars, which generate almost exclusively carbon dioxide and water, has meant that regulatory demands have not kept pace. Modern cars with catalytic converters generate 100-900 times as much CO₂ as CO. This means that the otherwise harmless CO₂ gas can itself create a greater threat to safety than the toxic gas CO! In high concentrations CO₂ is a deadly gas (used in slaughtering pigs!) – a

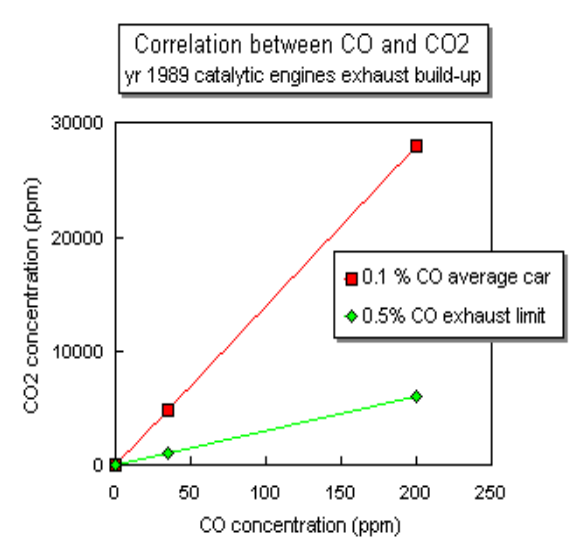

Figure 4: Correlations between accumulated level of CO and CO₂ for car exhausts (cat. converter cars). The lower curve shows test requirements from Swedish Testing Authority, while the upper curve gives an example of a more likely situation for a warm catalytic motor. In the latter case the high CO₂ -level represents a greater threat than the CO-level.

danger which can no longer be ignored in exhaust contexts. This applies especially to private car garages, which are used for commuting to and from places of work with a well-defined diurnal rhythm. During the interval of time when many cars are started simultaneously and engines are initially cold, the CO-level is the greatest risk-factor (Figure 3). During the opposite phase, when many arrive at the same time, engines and their catalytic converters, for hot or cold engines Figure 4 illustrates the correlation between CO and CO₂ for cars manufactured after 1989. The lower curve illustrates the case of cars which exactly fulfill the emission requirements for the Swedish Vehicle Testing authority, where CO-levels may not exceed 5000 ppm (=0,5 %). It is more usual, however, for CO-emissions to lie well below this level (upper curve). When these emissions are combined, the CO₂ limits will be exceeded long before the corresponding limits for CO!

Ventilation System for garages

Displacement systems in combination with **one-way flow** have the advantage of making high air-exchange efficiency possible. Because the driving force consists of density differences it is easy for thermal effects, vehicle movements etc to upset the intended flow. Ideally, the emissions accumulate along the flow-path and are forced out (Figure 5). Theoretically, therefore, the highest concentration of contaminants is at the point of air extraction. It might then be possible for a single channel-sensor to provide a solution to demand control of ventilation., but usually this is not enough. In one-way flow systems there is usually a considerable distance between in- and outflow points. This fact is responsible for a time delay in the system which can be unacceptably large – particularly in cases where a source of contamination is located close to the inflow point and the system initially functions at low speed. The minimum flow rate calculated for the locale determines the density of placement for the sensors in the direction of flow. When calculating one must also take into consideration that vehicle movements create turbulence which mixes the air, and in narrower passages also push the air in front of them in a piston effect. Thermal effects must also be considered. The system should therefore be designed to accommodate easily more sensors, or to redistribute the inflow.

Mixing systems in garages have the positive attribute that sources of emission are quickly diluted to less dangerous levels. The disadvantage is that instead a large number of in- and outflow points must be installed in order to ensure a mixing effect over the whole area (see Figure 5).

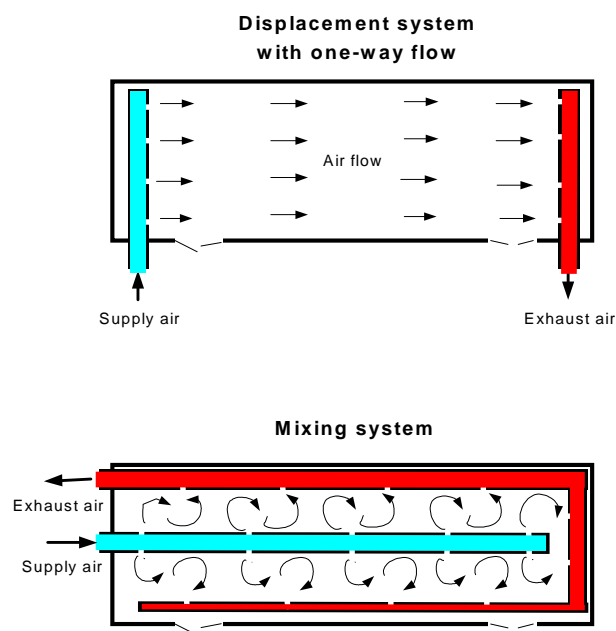

Figure 5: Two different functioning principles for garage ventilation

There is a risk that a "short-circuit" may occur at certain points between in-and outflow, so that parts of the locale can be left without air-exchange. On the other hand, with a "blending" system the area can more easily be divided into several control zones, where the air exchange in each zone can be controlled on the basis of immediate demand. This can be valuable in cases where the vehicle park tends to be unevenly distributed in the garage – for example close to the paybooth in a shopping mall. During periods of low use only the occupied zone needs to be ventilated, rather than the whole garage.

A **combined ventilation solution** may be the optimal one. To sum up, the following applies:

- Avoid long airflow paths where excessive levels of contamination can build up at the end of the field of flow.
- Maintain short fields of flow in areas where high emissions of contaminants are to be expected.
- Ensure safe and efficient air exchange over the whole parking area.
- Try to avoid stratification of engine exhausts.
- Ensure optimal placement of air inflow ducts so that these are not contaminated by outflow or other adjacent exhaust emission sources.
- Take into account thermal comfort for visitors.
- Ensure that the system can be conveniently expanded with more sensors or that the air can be redistributed.

Intermittent management of mechanical ventilation is from the investment point of view a highly economical solution. With demand control a simple method such as this can be made both energy efficient and safe. A certain amount of involuntary ventilation and natural draught always occurs. This can sometimes be sufficient for basic ventilation, whereby the function of climate sensors is reduced to *starting* mechanical ventilation when a genuine demand has been detected, and *stopping* it when air quality is again acceptable. But the addition of time-control to demand is to be recommended, with a recurring brief compelled air renewal. Otherwise there is a risk of concentration of unhealthy gases from e.g. petrol-and oilspills. The acceptable interval between periods of compulsion is dependent on the garage's volume in relation to load and natural draught. Natural draught ventilation varies of course with differences of temperature and thereby season, so that measurements should be made to verify the system's function under different conditions. Such measurements can be made, for example, by placing an extra climate sensor somewhere between the demand control sensors, in order to include the most unfavourable case (Figure 6). The extra measuring instrument should be data-logged during at least one weekly cycle in order to provide a picture of the natural variations of load in the locale.

Sensor Placement

Obviously it is not easy to make a general statement about the placement of sensors in a ventilation system, particularly when the sources of emission are mobile. The state of the individual building, with respect to ventilation system, airflow, parking places, vehicle routes and visiting-areas must all be taken into account. Swedish standards provide no specific directions about the placement of climate sensors in garages. From the regulations of other countries it is however possible to formulate the following *rules of thumb*:

- An Absolute maximum of 500 m² floor area per sensor
- Installation level above floor – "nose-level"

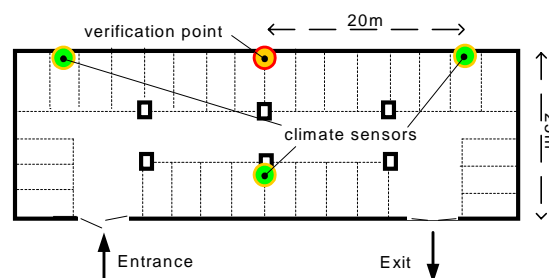

Figure 6: A Schematic example of sensor placement for demand-control in a garage with <1500 m² floor area. A suitable sensor station for temporary control measurement is also indicated.

There is for example a maximum permitted distance between CO sensors in garages laid down in the Australian standard 1668.2-1991. This imposes max 25 metres between sensors and an installation level between 0,9 and 1,8 m. Similar requirements are to be found in the German garage standard VDI 2053:1, which recommends an installation level of 1,5-1,8 m above the floor (max 2,2m) and at least two CO-sensors per control area (max 1000 m² per pair).

CO weighs roughly the same as air, whereas CO₂ and NO₂ are considerably heavier. However, these differences in weight have no significance for exhaust dispersion. Thermal movements and pressure differences totally dominate over the force of gravity. Initially exhaust fumes rise upwards, since they are hot when they leave the exhaust pipe. Turbulence caused by the ventilation system and movement in the locale are then responsible for mixing the air. It is therefore logical to place the sensors at the height where the objects of protection, the visitors, are located. The sensors should *not* be placed at the level of the exhaust pipes! There are, however, *other* contexts where CO₂-sensors should be installed at a low level. But this only applies in sealed areas without ventilation, for example deep-freezes, storage rooms for fire-fighting equipment, cellar stores for beer etc, where CO₂ containers are stored in a static air environment, and therefore represent a serious risk-factor.

Response time

The determination of hygienic limits is based on medical research, where the ability of human blood to absorb different gases has been studied, including the resulting symptoms and after-effects. The risk factor increases with the concentration of gas, the time of exposure, and the individual heart/lung activity at the time of exposure. CO-absorption in the blood occurs through the production of carboxyhaemoglobin (COHb), which can lead to oxygen deficiency (hypoxia). Figure 7 and Table 2 show approximate correspondences between exposure times and CO-level for three different levels of activity of the human body, under the condition that the COHb level in the blood reaches 3,5%. This, roughly speaking, is the limit that is generally acceptable - even for sensitive people with, for example, heart/lung problems. In Sweden BBR 94 provides a healthy margin of safety. This can be compared with the USA, where UL2034-standard for CO warning permits 100 ppm during 90 minutes, as opposed to 15 in Sweden.

Table 3 shows the body's reaction to increasing levels of COHb. For example, we see that a healthy person does not experience discomfort as long as the blood-level is 10% COHb, which is the aim of the US regulations.

Alveolar ventilation	6 l/min waking rest	15 l/min light work	20 l/min heavy work
Concentration CO ppm	Exposure time in minutes		
1000	18	10	8
500	24	13	11
300	34	18	15
200	46	24	21
150	58	31	27
100	86	46	39
75	117	62	53
50	191	102	87

Table 2: CO-exposure time to reach bloodconcentration 3,5% COHb [5,6].

Ventilation system's response time can be divided into a number of different components – from exhaust emission to fresh air ventilation:

- 1) The flow emission travel from source to sensor station.
- 2) The response time for the diffusion of the gas through the sensor's protective capsule.
- 3) The time taken for the gas detector to reach the programmed level of activation.
- 4) The ventilation system's reaction time.
- 5) The flow time from the inflow point to the activating sensor (or the visitor's position).

These different components must be taken into account when the system is constructed and specified. Point 1 is affected by the geometry of the locale, the minimum flow and the distance between sensors.

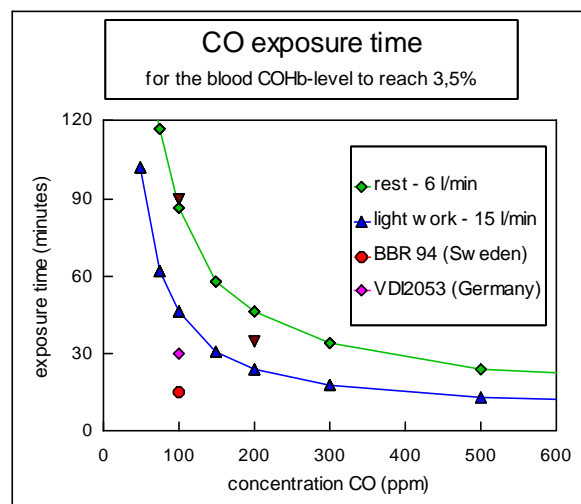

Figure 7: Approximate correlation between exposure time and CO-level for some different levels of activity in the human body, under the condition that COHb-level in the blood reaches 3,5% (by Colbourn's formula [5,6]). Limit values for present standard in Sweden, Germany and USA are also indicated.

Concentration COHb %	Symptom
50	permanent brain damage - death
45	coma and permanent brain damage
40	collapse
35	vomiting
30	dizziness
25	headache and nausea
20	headache
15	light headache
<10	none
2-3	natural level in smokers
< 1	natural level in non-smokers

Table 3: A healthy person's reaction to different levels of COHb in the blood (from ref.[7]).

Point 2 by the density of the sensor's capsuling, where the manufacturer must compromise between speed and quality of protection (for example, washability); point 3 is limited by measurement technique, but can be affected by choice of activation level. Points 4 and 5 depend on the ventilation solution and flow specification.

Figure 8 shows response times (the total effect of capsule diffusion and sensor time) which are to be expected for a normal installation of SenseAir's climate sensors for CO/CO₂; model *mSENSE II*. The integrating effect of the sensor on the measurement result is positive in the respect that short-time variations are not allowed to affect the ventilation system. A car starting or passing close by a sensor should not cause the system to instantly switch over to full effect!

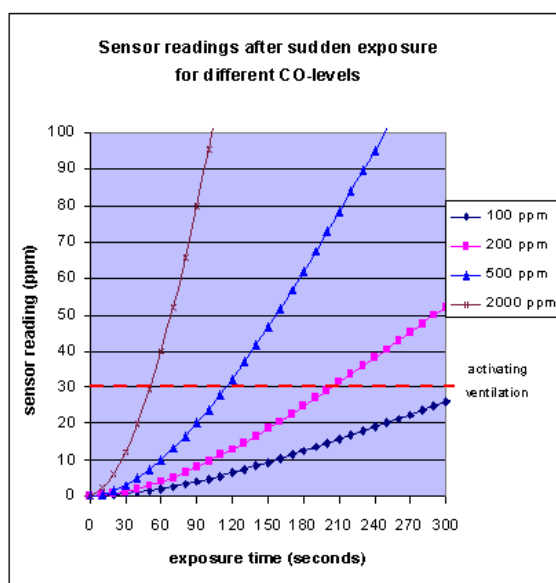

Figure 8: Reaction times for SenseAir's CO-sensor in IP54-capsuling. The more dangerous the level of CO, the shorter the reaction-time before the ventilation system's activation level.

In a demand-controlled ventilation system the sensor's inertia with regard.. to sudden changes is parried by a well-judged activation level. Our recommendation is to adjust it to about half the limit values. For a two-stage ventilation based on CO measurements the activation level for compelled ventilation should therefore be around 40-60 ppm. For linear control we suggest that the dynamic field (P-band) should, for similar reasons, be set 30...80 ppm. A basic ventilation of some kind is of course required in both cases, whether it is natural draught, constant low speed, or intermittent (set time intervals).

The climate sensor *mSENSE II* [4] can send control signals based on the combined ventilation requirement of all the different climate parameters CO, CO₂, humidity and temperature. The activation level for CO₂ is subject to discussion. To use the short-time value 10 000 ppm appears rather drastic in view of the fact that the source of emission is exhausts which also almost certainly contain carcinogenic substances and NO₂. It is better, then, to use CO₂ as an exhaust indicator and programme an activation level somewhere between 1000...3000 ppm. This can be compared with a study of diesel vehicle environments in the USA which shows that NO₂ levels were maintained within approved 8-hour limits when the CO₂ levels lay under 1330 ppm [3].

In cases where excess air from adjacent locales is used as inflow in garage ventilation, the CO₂ concentration can already initially be up to 1000 ppm. In that case, 2000 ppm is perhaps a reasonable activation level for the garage.



Figure 9: SenseAir's CO sensor *mSENSE II* in IP54 housing.

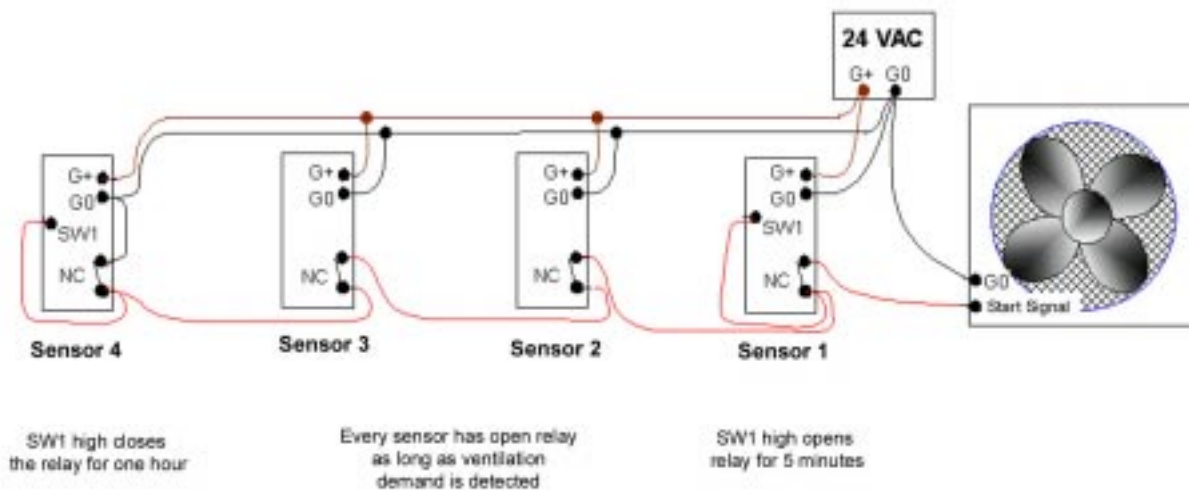

Figure 10: An example of cost efficient intermittent demand controlled ventilation combined with time set interval for basic ventilation.

An example

Figure 10 shows how – in this case 4 - climate sensors of type *mSENSE II* can be co-ordinated in a garage in accordance with the following specification of function:

- 1) The criterion is that air renewal is controlled ON/OFF via a ground circuit, where the control terminal "Start signal" is assumed to be logically "high" when it is not connected. When the circuit *G0 - sensor 4 - 3 - 2 - 1 - start signal* is switched off the fan is activated until the circuit is reconnected,
- 2) All the sensors switch off their relays "NC" if one of the following things happens:
 - a) CO level exceeds 30 ppm
 - b) CO₂ level exceeds 1500 ppm
 - c) temperature exceeds 27 °C
- 3) Sensor senses the circuit's initial start signal status via the digital input SW1. Every time the circuit is broken, and the fan starts, SW1 initiates an internal clock which ensures that the circuit remains broken for 5 minutes – irrespective of the reason for the start. Sensor 1 thereby ensures that the fan is always active for 5 minutes after the original demand for it has disappeared.
- 4) Sensor 4 has, in addition to its demand-control function, the function of starting the ventilation in the event that it has not been active during the last 60 minutes. It does this by sensing the circuit's initial start signal status via SW1 and disconnecting the circuit if it has been at "low" level during a continuous 60-minute period.

For the confidence of the general public, one may in addition to the demand-control also define an alarm level, which if it is exceeded, activates a visual warning signal. The alarm should be activated when the CO-level exceeds 100ppm and STEL might therefore be exceeded for anyone remaining in the area. *mSENSE II* supports simultaneously alarm generation, demand-control with several control parameters, and analogue signal for data-storage of, e.g. CO-levels. Terminal wiring which illustrates the possibilities of this product can be found in Figure 11.

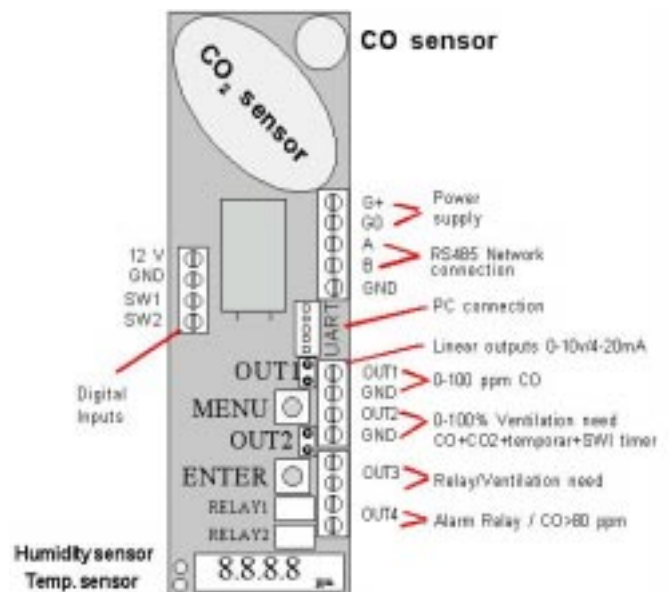

Figure 11: Connection options that demonstrates the flexibility of the climate sensor *mSENSE II*.

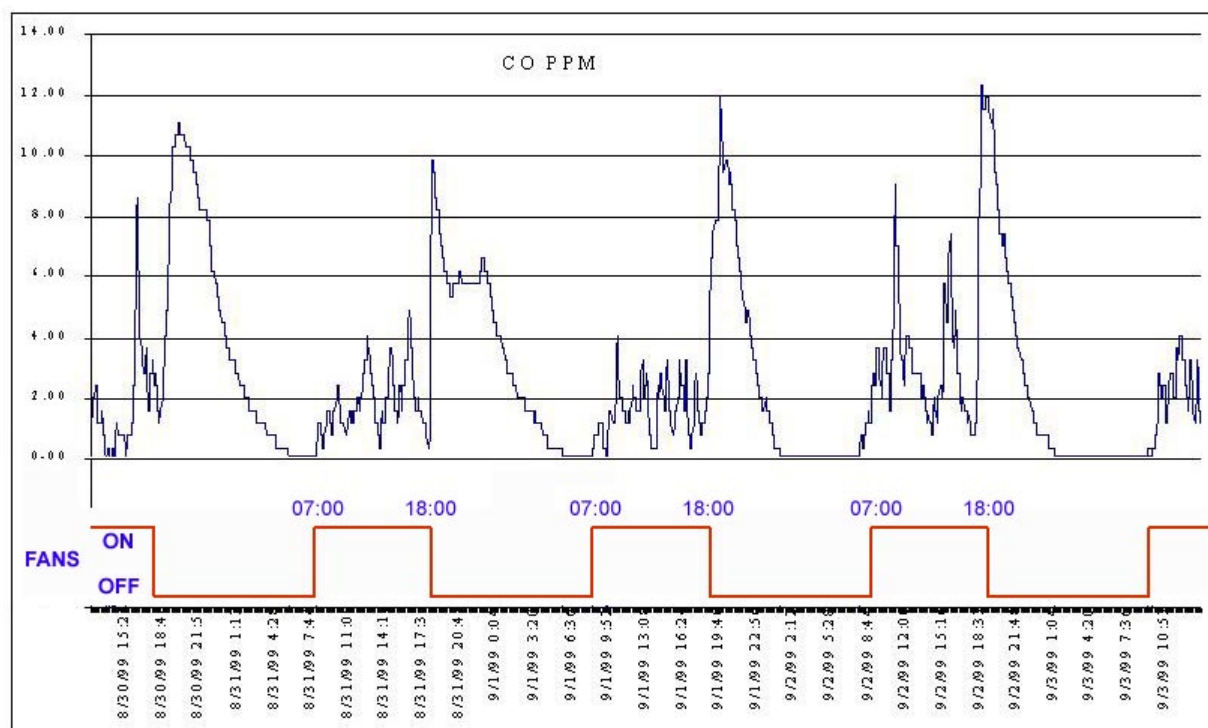

Figure 12: An example of measurement from a mSENSE 11 installation in Singapore during August 1999 - Gleneagle Basement Car Park. The fans (4x22kW per floor) run at full effect daily between 7 am and 6 pm, which is a clear case of over-ventilation. As the figure shows, the CO-level increases temporarily every evening when the fans are shut down. After introduction of a two-stage demand-control system (start-up at 30 ppm CO or 1200 ppm CO₂ or 34 °C) running time decreased by an average 85%.

To save as much energy as possible, it is of course necessary to lie close to the limits. An adjustment of activation levels is therefore necessary under running conditions, with follow-up and verification based on continuous data-registration. Figure 12 shows a common example: Before demand-control was activated distinct over-ventilation could be

demonstrated by registration of CO-emission data.

On most days emissions did not exceed 5 ppm when the fans were running (7 pm - 6 pm). By means of a simple demand-control the fans running time was reduced to, on average, 15% of the previous figure, with corresponding saving of energy as a result!

REFERENCES

1. National Oceanic and Atmospheric Administration (NOAA), Climate Monitoring and Diagnostics Laboratory (CMDL), Carbon Cycle-Greenhouse Gases, www.cmdl.noaa.gov/ccgg
2. Healthy Buildings 2000, Workshop Summaries, *ISIAQ Conference Proceedings*, editor: Olli Seppänen. www.hb2000.org
3. US Dept. of the Interior, Bureau of Mines, Report #8884. *Diesels in Underground Mining*.
4. SenseAir AB, modell M-SENSE II, datasheet, www.senseair.com
5. Appl. Occu. Environ. Hyg., 1991, **6**, No.7, July, p.621-624
6. American Conference of Government Industrial Hygienists. *Threshold limit values and biological exposure indices 1992-1993*.
7. Underwriters Laboratories, *Standard for Single and Multiple Station Carbon Monoxide Detectors*, UL2034, Figure 37.1
8. Burnett J. and Chan M.Y. *Criteria for air quality in enclosed car parks*. Proc. Instn Civ. Engrs, Transp., 1997, **123**, May, p102-110.