

Item description/product images

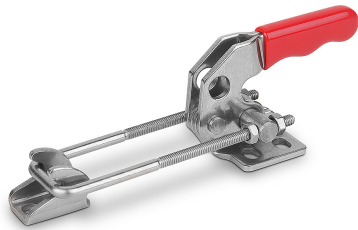

Description

Material:

Stainless steel 1.4301.

Version:

Bright.

Oil resistant plastic grip.

Note:

Latch clamps are especially suitable for quick closing and fastening of lids and hatches. The travel range of the locking bracket can be adjusted to suit.

Drawings

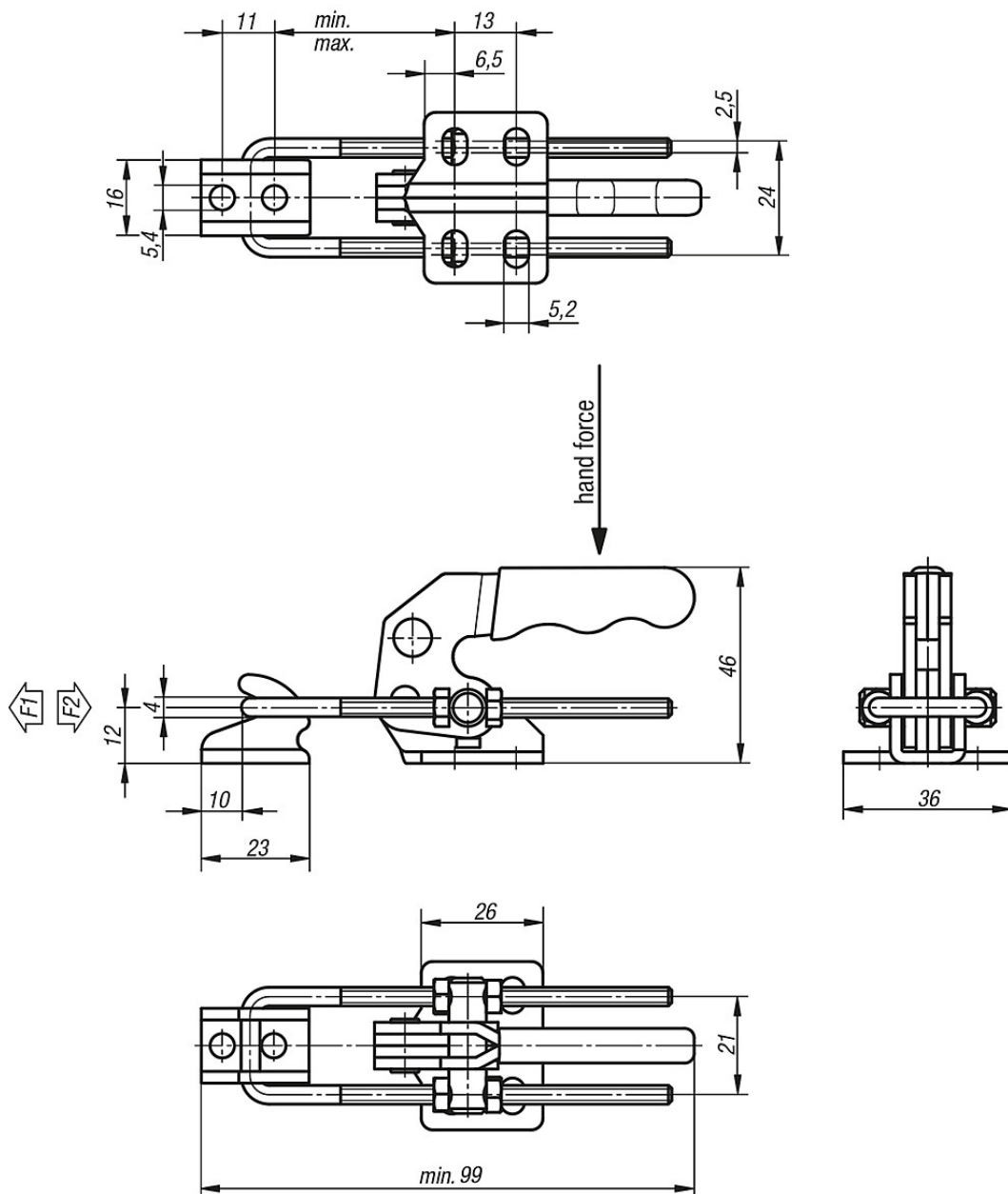

Overview of items

Order No.	Hand force N	Retaining force F2 N	Pull force F1 N	Approx. weight kg
40-120-1	100	2.000	1.800	0,12