

Split shaft collars

Example of applications

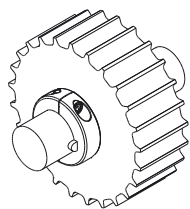

Sprockets

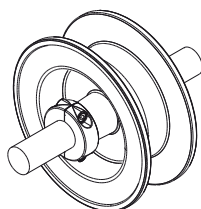

Idler wheels

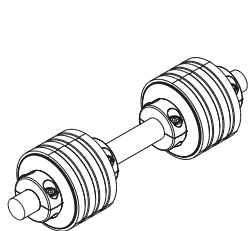

Rollers for chain return

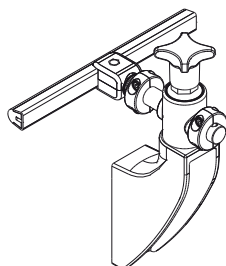

Guide rail bracket

Split shaft collars Part. 288

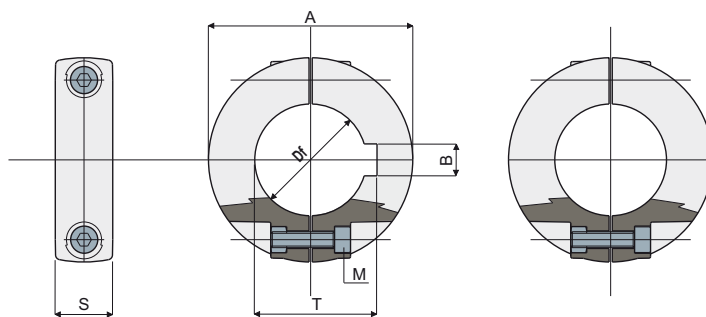

With Keyway

Without Keyway

With keyway						Code
Df (mm)	A (mm)	S (mm)	M (mm)	B (mm)	T (mm)	
20	40	14	M4	6	22,8	288 / 82555
25	50	14	M5	8	28,3	288 / 82556
30	50	14	M5	8	33,3	288 / 82557
35	65	14	M5	10	38,3	288 / 82558
40	65	14	M5	12	43,3	288 / 82559

Without keyway				
Df (mm)	A (mm)	S (mm)	M (mm)	Code
12	35	13	M4	288 / 82560
14	35	13	M4	288 / 82561
16	35	13	M4	288 / 82562
18	40	14	M4	288 / 82563
20	40	14	M4	288 / 82564
25	50	14	M5	288 / 82565
30	50	14	M5	288 / 82566
35	65	14	M5	288 / 82567
40	65	14	M5	288 / 82568

MATERIALS: Collars made out of reinforced polyamide black colour; bolt and nuts made out of stainless steel AISI 304.

FEATURES: Supplied assembled. To be assembled on the shaft to obtain wheels axial blocking; to be assembled on pins for guides supporting to adjust the position of guides according to the bottle size.

BOX QUANTITY: 96 pieces.

ON REQUEST:

- Collars: With special bores, other colours.
- Box Quantity: According to your request.

Split shaft collar Part. 376 (with square bore 40x40)

Example of application

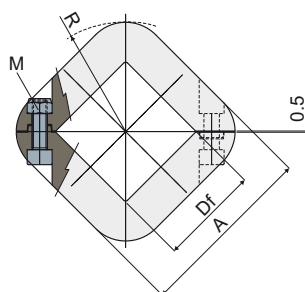
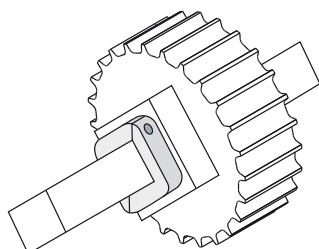

M (mm)	Df (mm)	A (mm)	R (mm)	Code
M6	40	72	44	376 / 83895

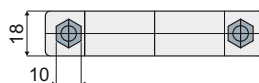

MATERIALS: Collars made out of reinforced polyamide black colour; self-locking nuts made of stainless steel AISI 304; screws made of stainless steel AISI 316.

FEATURES: To be assembled on the shaft to obtain wheels axial blocking.

BOX QUANTITY: 96 pieces.

ON REQUEST:

- Box quantity: According to your request.